



ES1000

EMAIL APPLIANCE

SETUP GUIDE

- 1 PREPARATION
- 2 RACK INSTALLATION
- 3 APPLIANCE RAIL ATTACHMENT
- 4 CABLING THE APPLIANCE
- 5 SOFTWARE/NETWORK SETUP

CAUTION

! This appliance is intended for installation in restricted areas only. Initial setup and maintenance should be performed by qualified personnel.

• • • • •

! Required operating conditions for the appliance are -
Temperature: 10 to 35 °C.
Humidity, non-condensing: 8 to 90%.

• • • • •

! Install and operate the appliance in a compatible rack only. Any other type of installation or use is not supported.

• • • • •

! To prevent the unit from overheating, never install the appliance in an enclosed rack or a room that is not properly ventilated or cooled. For proper airflow, keep the front and back sides of the appliance clear of obstructions and away from the exhaust of other equipment.

• • • • •

! Electrostatic Discharge (ESD) precautions are required before handling the appliance. Wear a wrist strap with an appropriate ground connection.

• • • • •

! Power down the appliance by pressing the power button. The appliance will safely shut down its software and the fans will stop. Remove the power cord before servicing the unit.

• • • • •

! Failure to properly ground the appliance, either by circumventing the 3-wire grounding-type plug or by using a power outlet that is improperly grounded, can create a potentially hazardous electrical situation.

• • • • •

! Do not use mats designed to decrease static electrical discharge as protection from electrical shock. Use only mats that have been specifically designed as electrical insulators.

• • • • •

1 PREPARATION



NOTE: Make sure you have a laptop or PC that can be connected to the rear of the appliance during step 3 of this guide to complete the ES1000 configuration.

Unpacking the Appliance

Ensure that the ship kit includes a power cord, the correct number of screws and cage nuts (pictured below), and the 19-inch and telco-style rack rail assemblies (described below).

Rack screws and cage nuts (19-inch and telco-style)



(Eight) M5 x 12
Flat head screws



(Two) 10-32 x 3/4"
Truss head screws



(Twelve) M4 x 4
Truss head screws



(Eight) M5 x 12
Cone Washers



(Ten) M6 Cage nuts

Both the 19-inch and telco-style rack assemblies consist of:

- (Two) long two-piece fixed chassis rails. During assembly, the inner rails are detached from the outer rail and fixed to the sides of the appliance. The outer rails are fixed directly to the rack.

19-inch rack assembly consists of:

- (Two) medium, fixed rack brackets.
- (Two) short, fixed rack brackets.

The telco-style rack assembly consists of:

- (Two) medium, fixed brackets.
- (Four) short, fixed brackets that attach to the long rails. Two of these brackets have threaded holes for securing the appliance in the rack (as shown in step 2b).



Setup Location

- Choose a setup location with proper temperature control, and adequate floor loading capacity for the current installation and for future growth.
- Install in or near appropriate AC outlets and Ethernet hubs or individual jacks (10/100 Base-T cables cannot be longer than 100 meters).
- Leave enough clearance, 65 cm (25 inches) in the front, and 75 cm (30 inches) in the back of the rack to provide access to appliance components and allow for sufficient airflow.

Rack and Appliance Precautions

- ALL RACKS MUST BE MOUNTED SECURELY. Ensure that all leveling jacks or stabilizers are properly attached to the rack. If installing multiple appliances in a rack, make sure the overall loading for each branch circuit does not exceed the rated capacity.
- Do not slide more than one appliance out from the rack at a time. Extending more than one appliance at a time may make the rack unstable.
- Install your appliance in the lower part of the rack for improved weight distribution and easier access to appliance components.
- Always keep the rack's front door and all panels and components on the appliances closed when not servicing to maintain proper cooling.

NOTE: The following installation procedures: **2a, 19-inch Width Rack** and **2b, Telco-Style Rack** are for use with the rails provided in your ship kit. Follow the instructions in either **2a** or **2b**, depending on the rack you are using.

If a different style of rail is used, refer to the instructions provided with that rail ship kit. You should also refer to the instructions that came with the rack you are using.

2a 19-INCH WIDTH RACK INSTALLATION

Step 1 (19-inch width rack)

- Locate the two long fixed rack rails. Remove each inner rail by sliding it all the way to the right and pressing the locking tab to release it. You will attach the inner rails to the sides of the appliance in part 3, **Appliance Rail Attachment**.

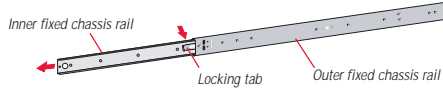

Step 2 (19-inch width rack)

- Attach the medium (A) and short (B) brackets to the outer fixed chassis rails. Attach each short bracket by aligning the two holes at the back of the front bracket with the two threaded holes at the front of each chassis rail and securing with M4 x 4 screws. Attach each medium bracket by aligning the slots on the bracket with the threaded holes on the chassis rail. Adjust the medium brackets to suit the depth of the rack. Secure using two M4 x 4 screws for each bracket.

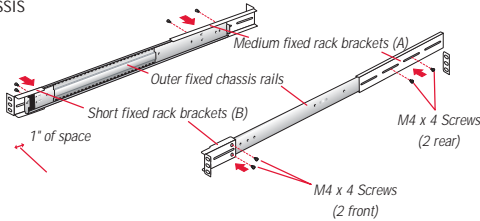

Step 3 (19-inch width rack)

- Insert a cage nut into each square hole (three in the front and two in the rear for each rail). They click into place. Attach the rail/bracket assemblies to the rack using two M5 x 12 flat head screws at the front and rear. The middle cage nut at the front will be used later to secure the appliance in the rack. Make sure rail/bracket assemblies and screws are properly aligned at the front and back and are level in height on the left and right sides.

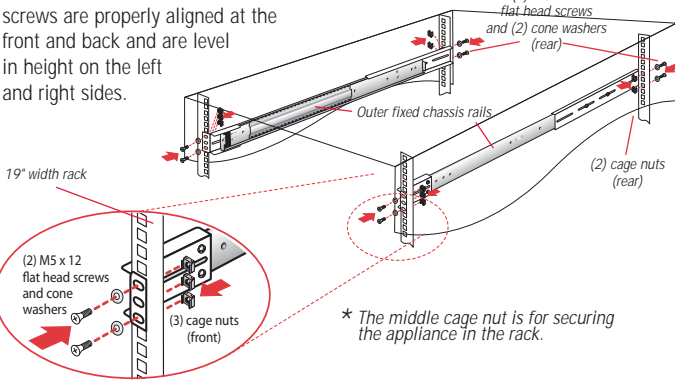

* The middle cage nut is for securing the appliance in the rack.

2b TELCO-STYLE RACK INSTALLATION

Step 1 (telco-style rack)

- Locate the two long fixed rack rails. Remove each inner rail by sliding it all the way to the right and pressing the locking tab to release it. You will attach the inner rails to the appliance in part 3, **Appliance Rail Attachment**.

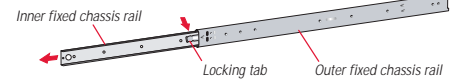

Step 2 (telco-style rack)

- Attach the medium (A) and short (B) brackets to the telco-style rack. Mount the short brackets in the front and the medium brackets in the back using two M5 x 12 flat head screws and cone washers for the top and bottom holes of each bracket as shown. Make sure the brackets are aligned in the rack in the front and back and are level in height on the left and right sides.

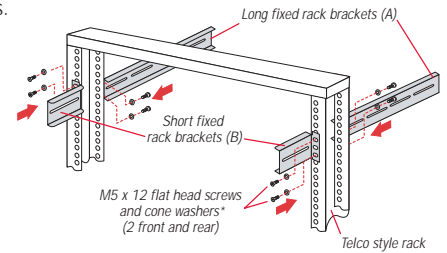

Step 3 (telco-style rack)

- Slide each of the outer fixed chassis rails into the left and right fixed brackets and loosely secure them with four M4 x 4 truss head screws on each side (See red dotted lines). Leave enough of the outer fixed rails extended in the front to loosely attach the threaded brackets (C) to the outer fixed rails using two M4 x 4 truss head screws on each side (See blue dotted lines). Once all four screws are in place, tighten each one to secure the outer fixed chassis rails.

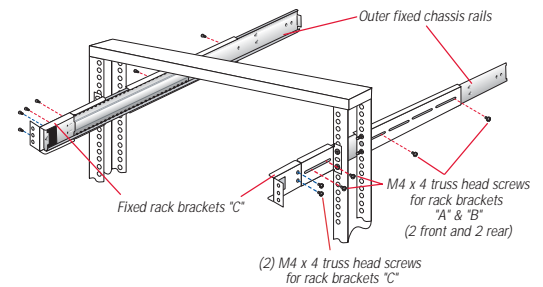

3 APPLIANCE RAIL ATTACHMENT

Step 1 (both racks)

- Mount the inner fixed chassis rails on the appliance using three M4 x 4 truss head screws on each side.

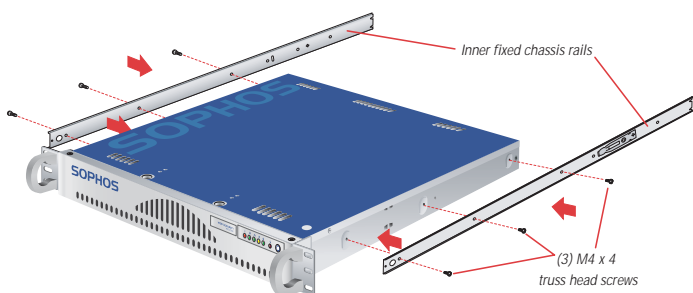

Step 2 (both racks)

- Align the inner fixed chassis rails on the appliance with the fixed rack rails attached to the rack. Carefully slide the appliance into the rack until you hear the rails click into place. Push the appliance all the way back into the rack until it stops. Secure the appliance in the rack using two 10-32 x 3/4" truss head screws. Attach the screws to the center hole of each three-hole tab.

